

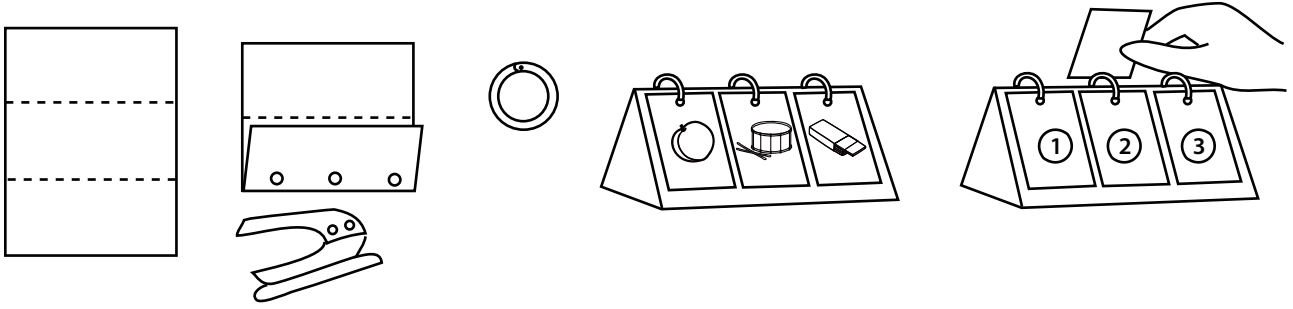



Flip Books: Rhyming Words Match

You need: construction paper, loose leaf rings, hole punch

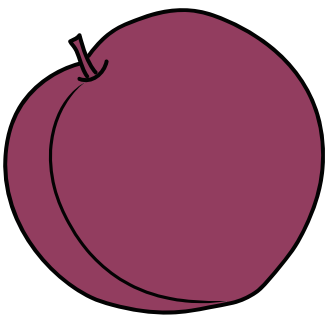
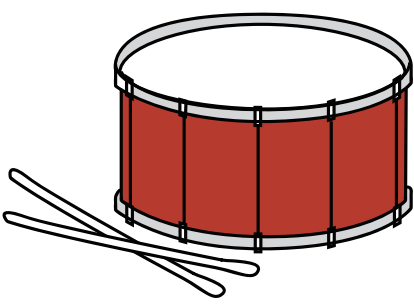

 <p>○</p> <p>①</p>	 <p>○</p> <p>②</p>	 <p>○</p> <p>③</p>
 <p>○</p> <p>①</p>	 <p>○</p> <p>②</p>	 <p>○</p> <p>③</p>

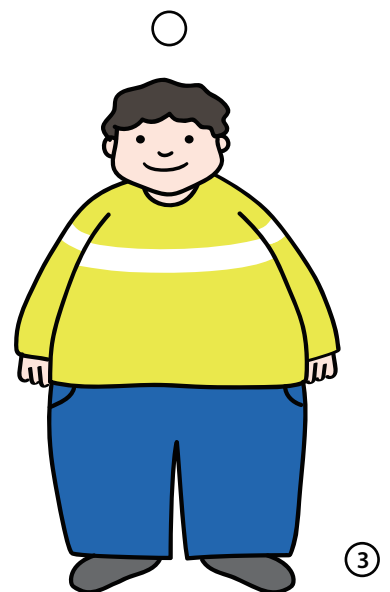
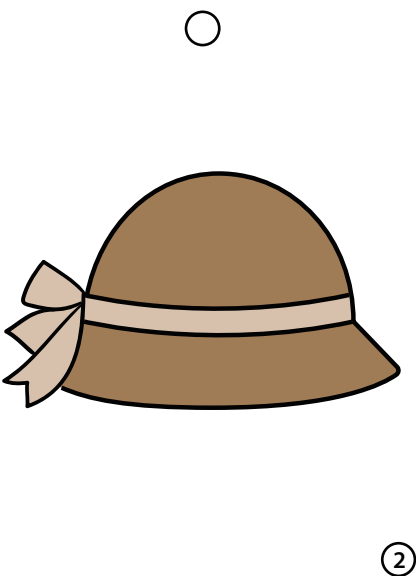
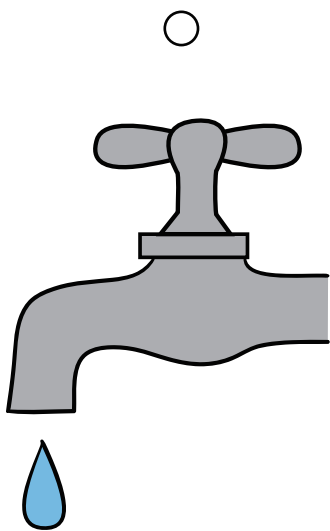
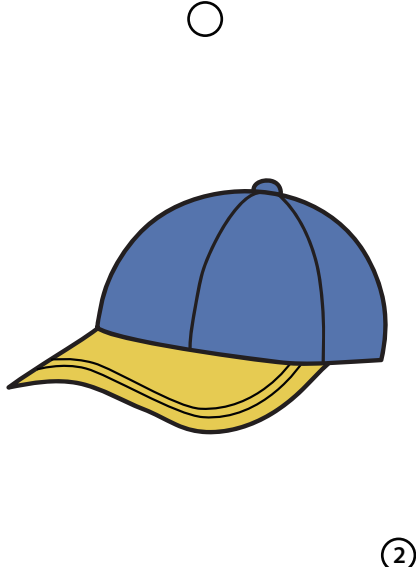
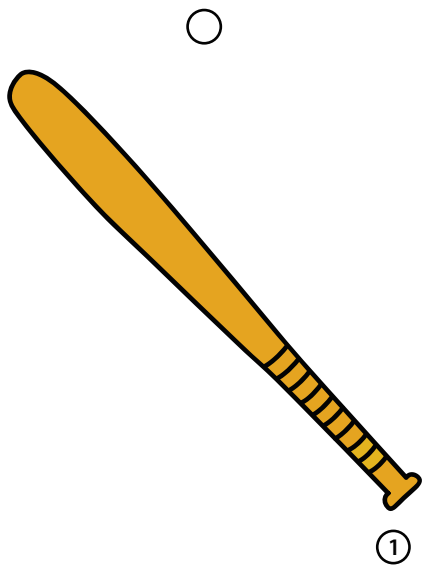
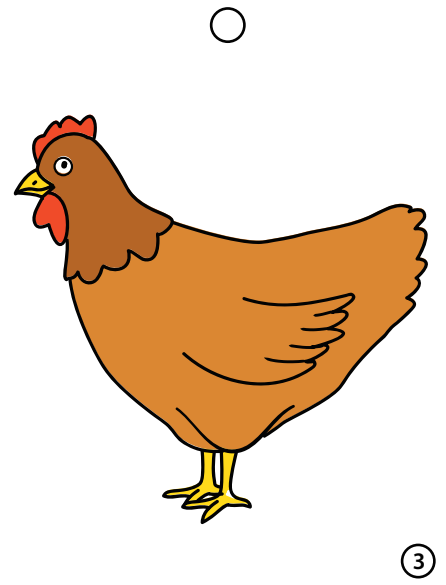
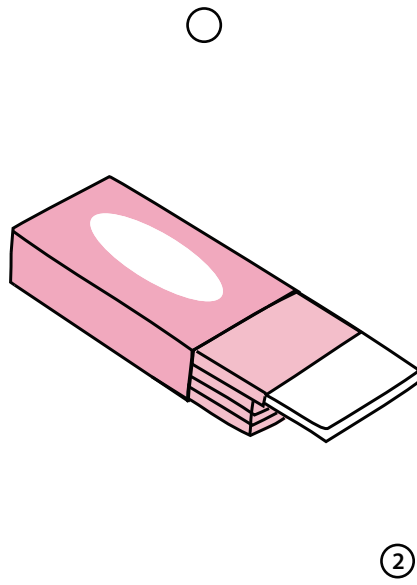
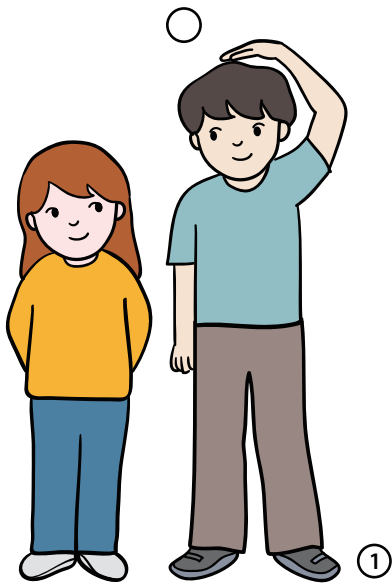

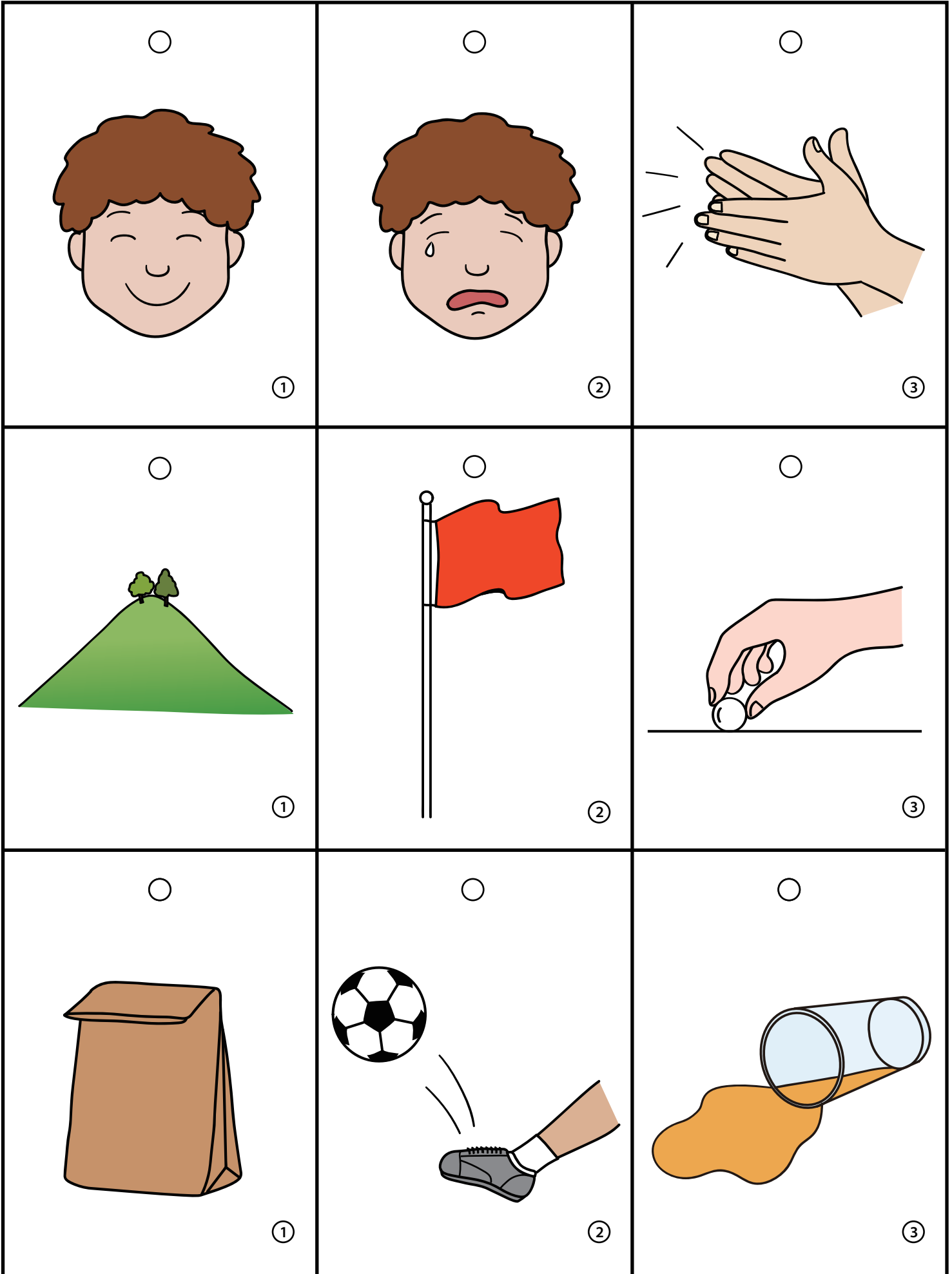

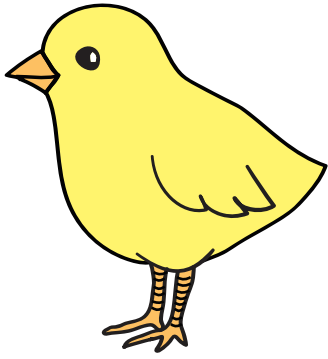

①

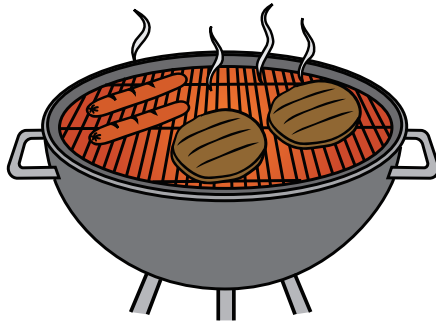

②

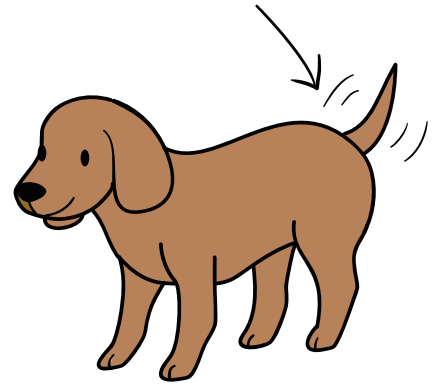

③

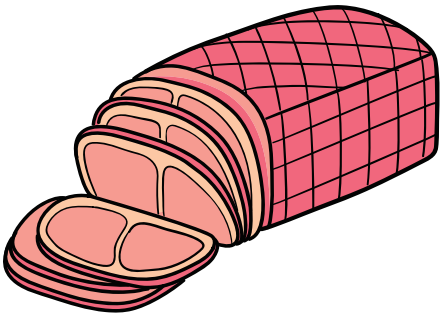

①

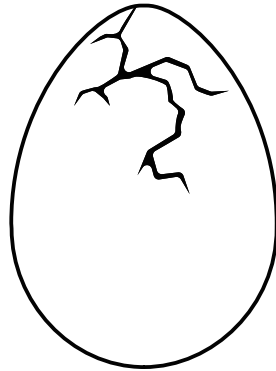

②



③

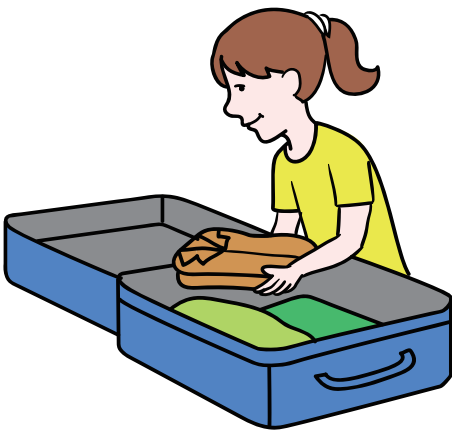

①

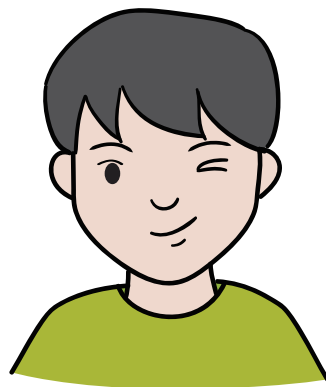

②

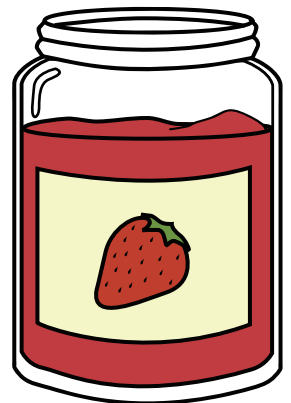

③

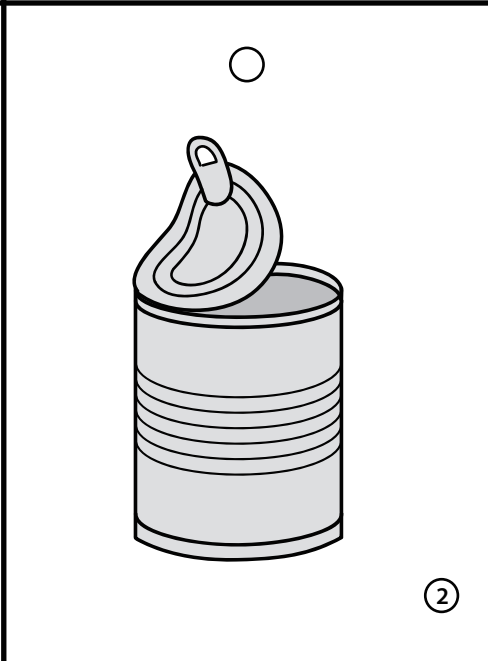
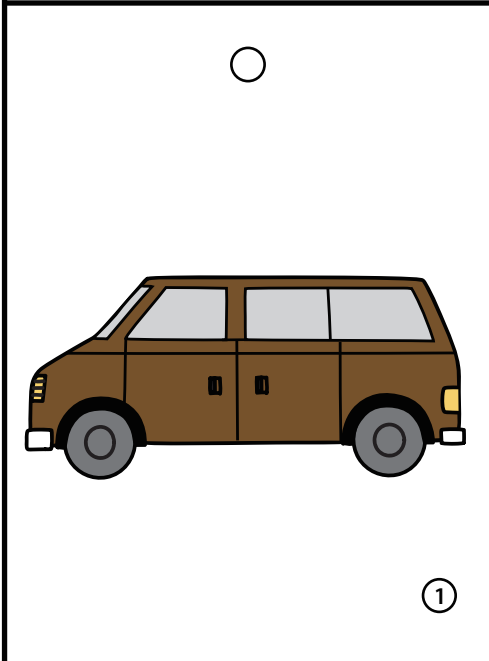
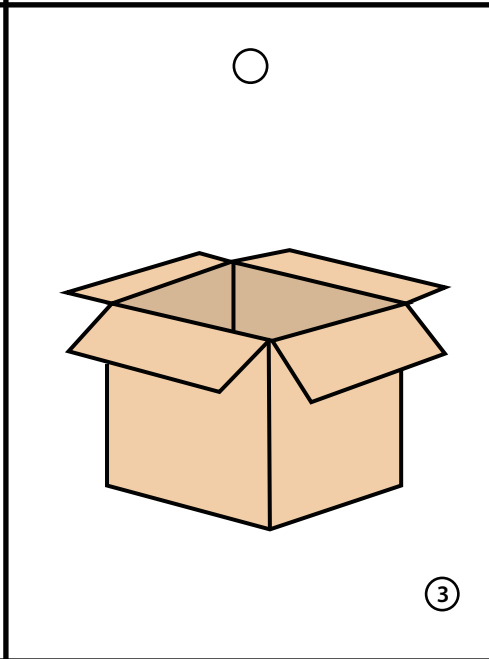
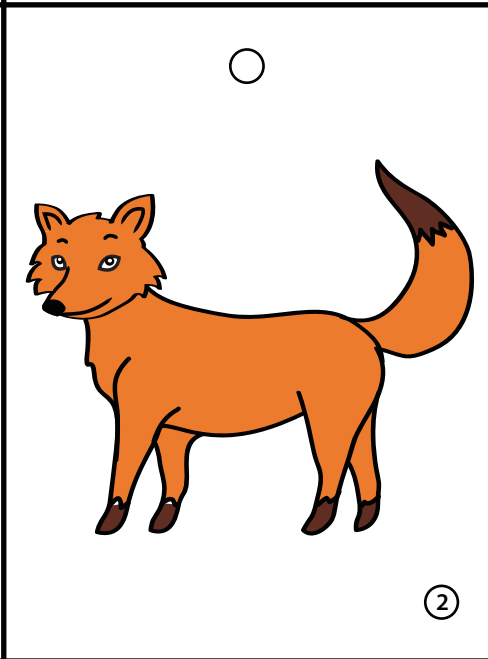
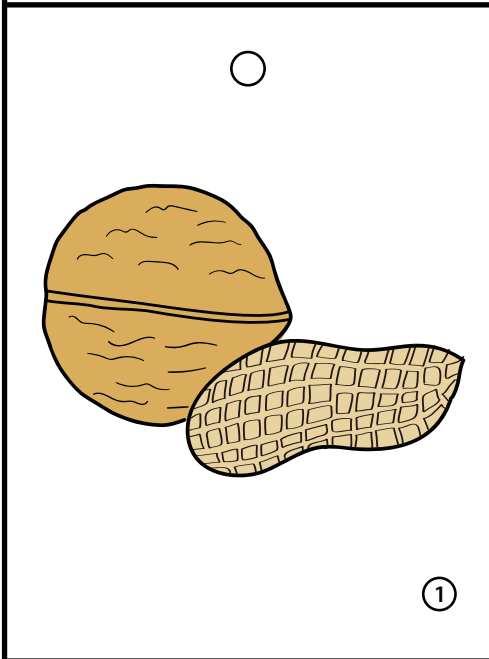
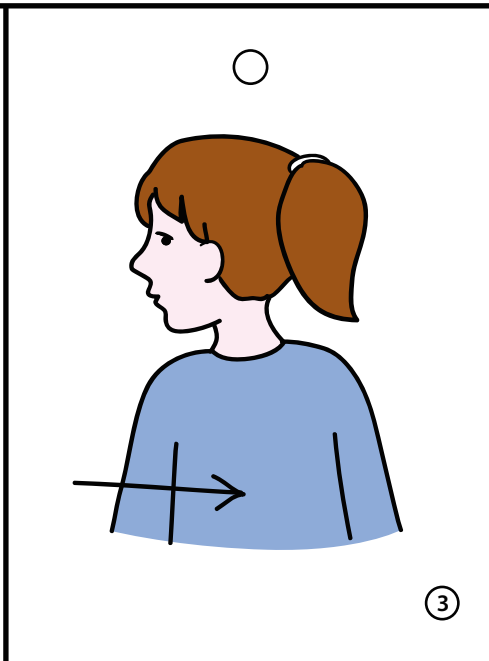
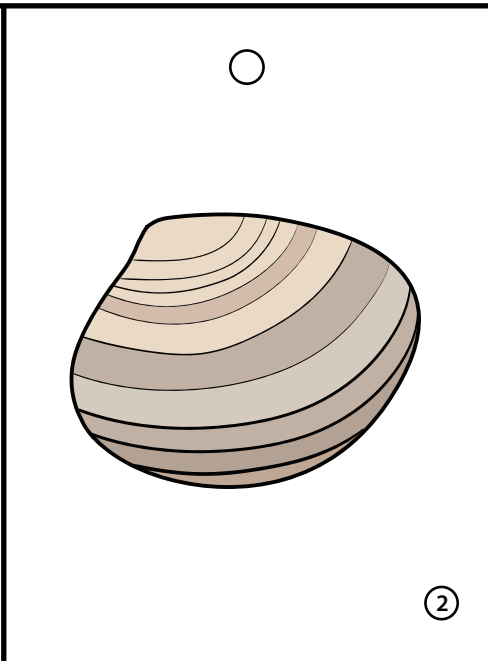
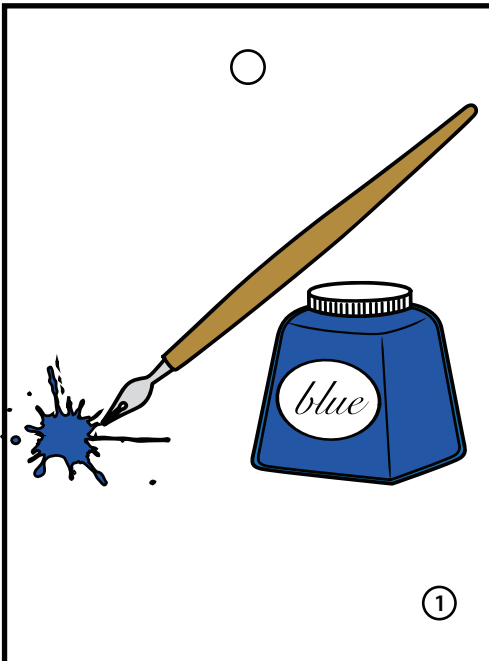

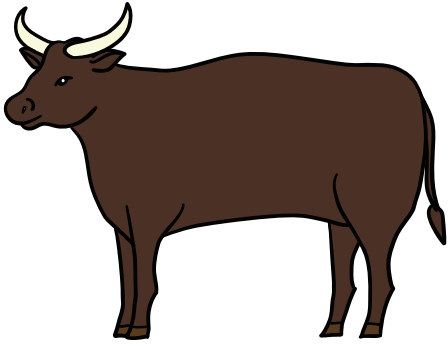

①

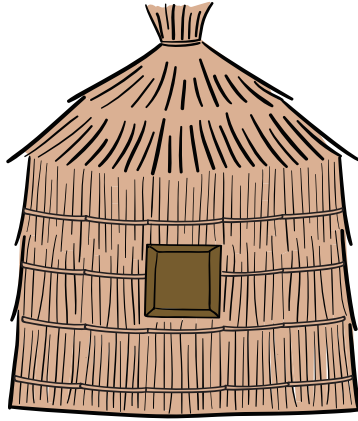

②

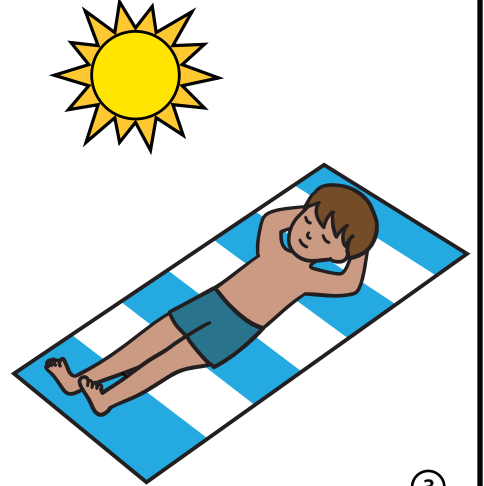

③

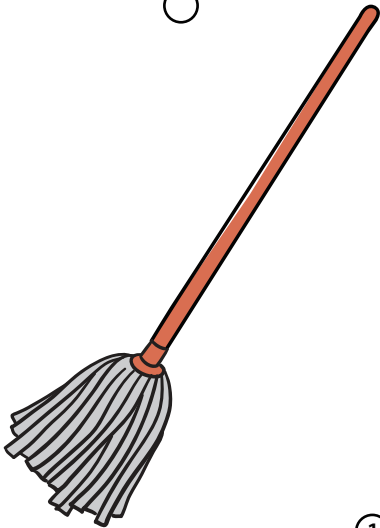

①

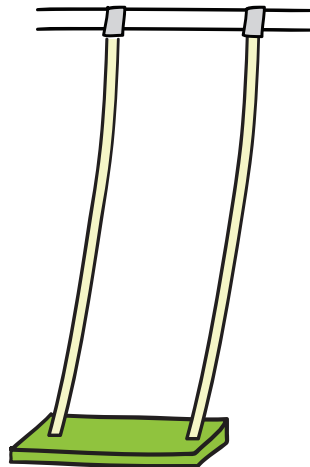

②

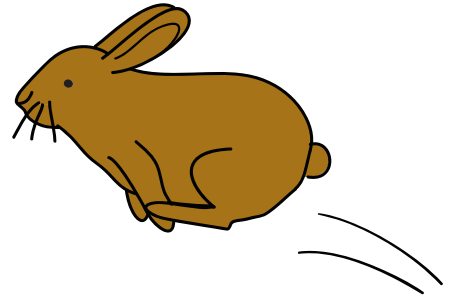

③

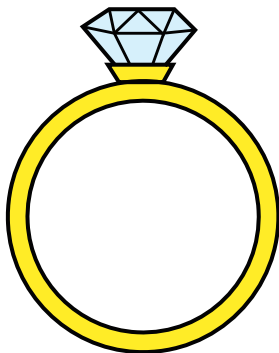

①

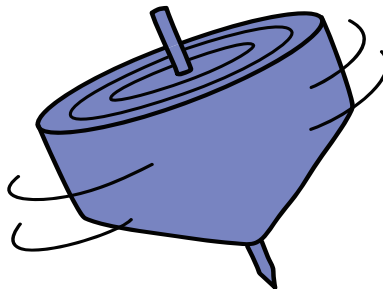

②



③

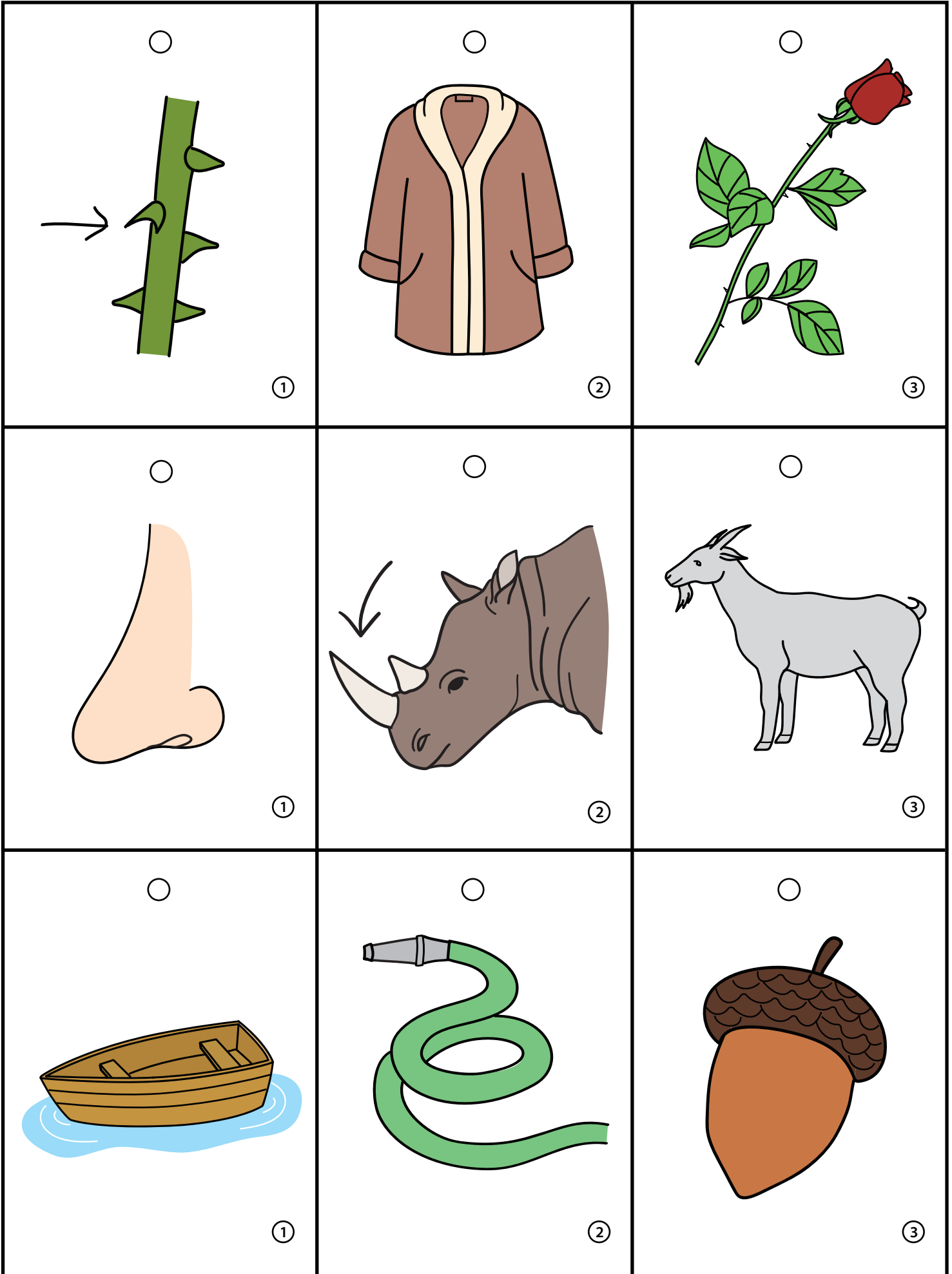



①

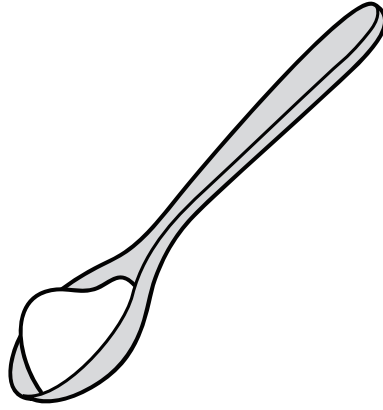

②

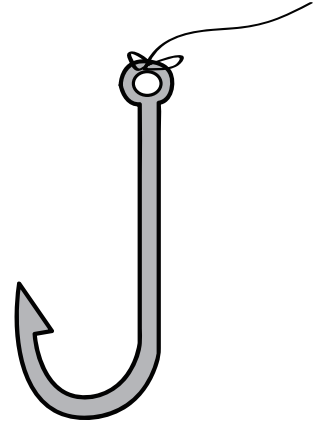

③

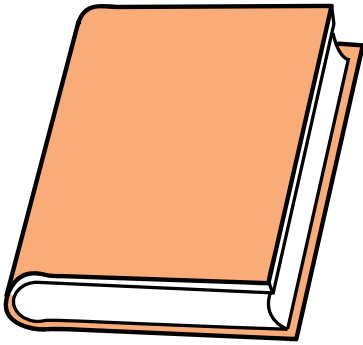

①

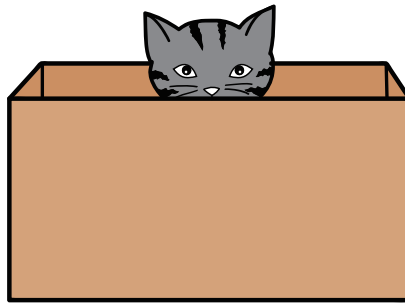

②



③

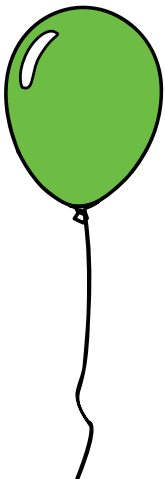

①



②



③

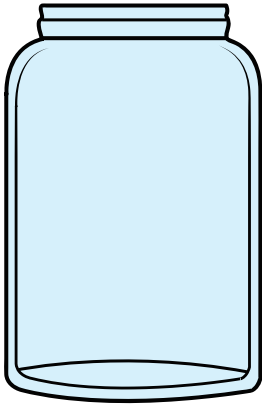

①



②

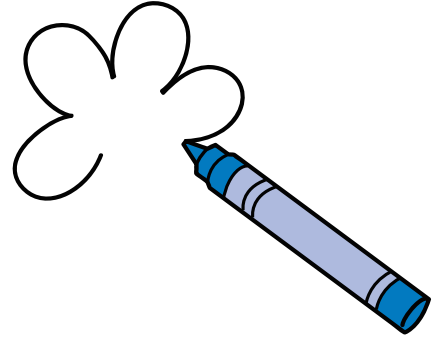

③

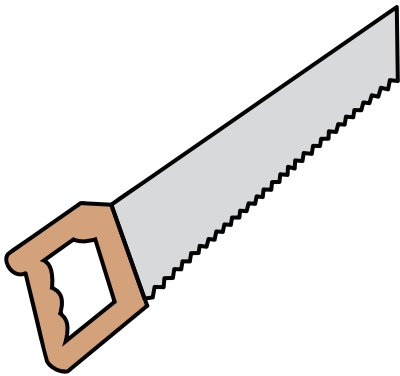

①



②

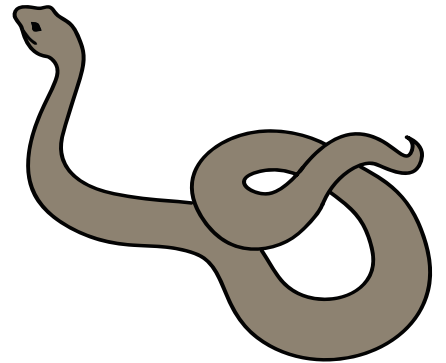

③



①

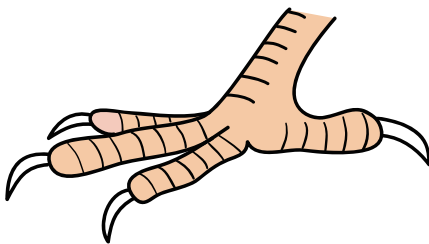

②

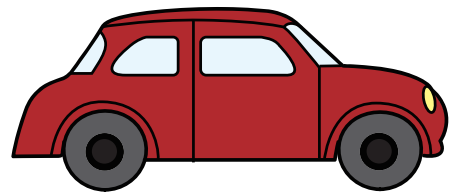

③

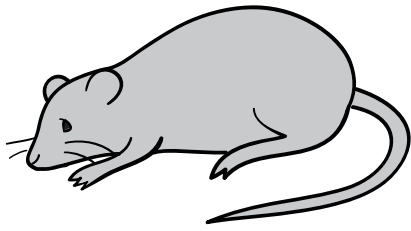

1

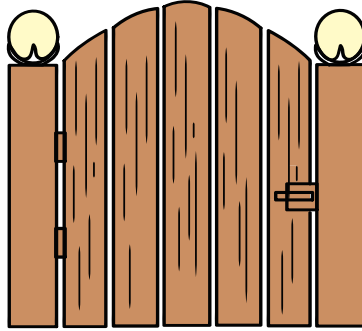

2

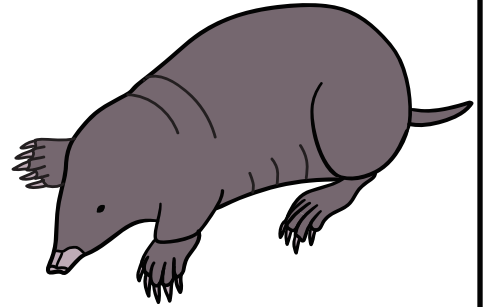

3



1



2

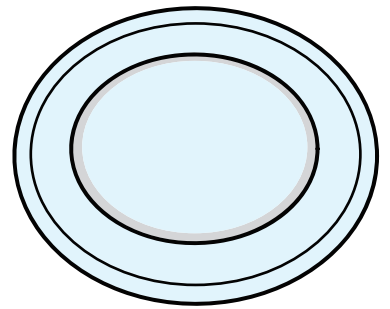

3

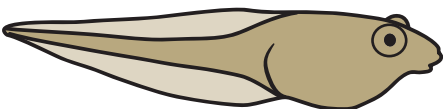

1

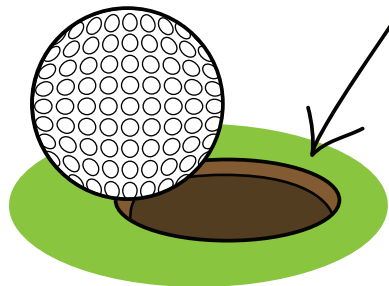

2



3